Grade 9: Complementary Courses

— For the 2026-2027 School Year —

Instructions

The following pages briefly explain the complementary courses that will be available for the 2026-2027 school year at Sister Annata Brockman, and any fee associated with that course. The last page contains a link to a Google form that will be used to indicate which complementary courses your child wishes to participate in. Please be aware that some courses can only be offered at specific times, and that students may not receive their top choices, as courses are dependent upon enrollment and teacher availability. Complementary courses will be assigned based on the date the form is completed and submitted.



Art \$35

Expand your creative potential and take your art skills to the next level! In this class, students will build skills while exploring a range of important artists throughout history. Students will work with art fundamentals including line, shape, space, texture, color and value. The grades 7 to 9 art programs are courses in which students create a variety of projects, such as an acrylic painting, watercolor painting, sculpture, drawing, a mixed media piece and more. Projects will change in style and level of difficulty from year to year so that students can build on their skills.



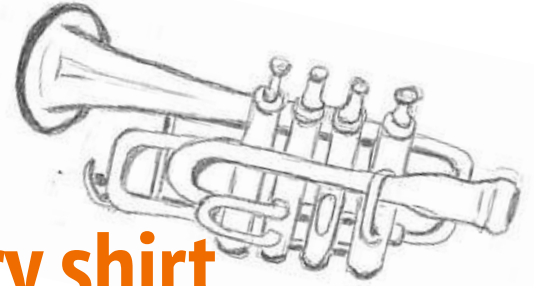

Band \$65 plus cost of mandatory shirt

Prerequisite Required to Take in Highschool- Research has shown that playing an instrument has many benefits, namely that it speeds the development of speech and reading skills, it trains children to focus their attention for sustained periods, and it helps children gain a sense of empathy for others and enhance overall coordination. Hone and develop the individual skill of learning an instrument while also being part of a team, all while playing music from different genres, cultures, and time periods. Our bands have several performances, ranging from band festivals to out-of-town camps and clinics.

Computers and Technology/Design \$30

This is a module based course that is student interest directed. Students are able to develop their problem-solving skills through a variety of modules relating to programming, information processing, robotics, stop-motion animation, video game creation, interior design, photography, digital art, 3D design and creation, print design and design in different mediums

This course will provide students with the flexibility to adapt to various situations that can be useful in future careers.

The modules available to students will depend on their grades and previous knowledge in a particular area.

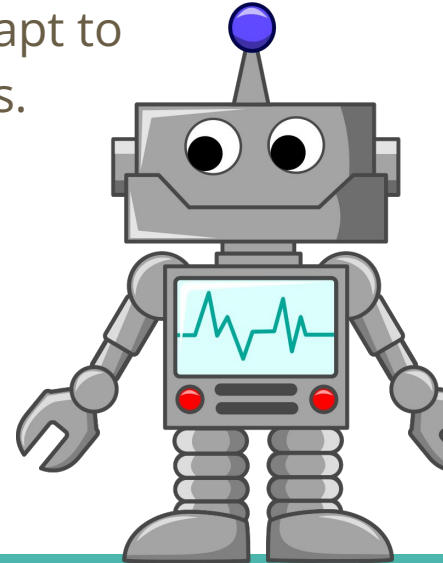

Construction \$30

The focus in Construction is developing skills and knowledge using some of the basic hand tools that are related to construction by safely transforming common wood materials into useful products. This will be completed by making hand projects like an oven squirrel, small projects like air dragsters and bandsaw boxes, to large projects like a cabriole leg stool or a carrying tray.

Students will also have the opportunity to use an auto Computer Aided Design (CAD) by taking a 2-dimensional drawing and putting it into a 3-dimensional program to be printed.

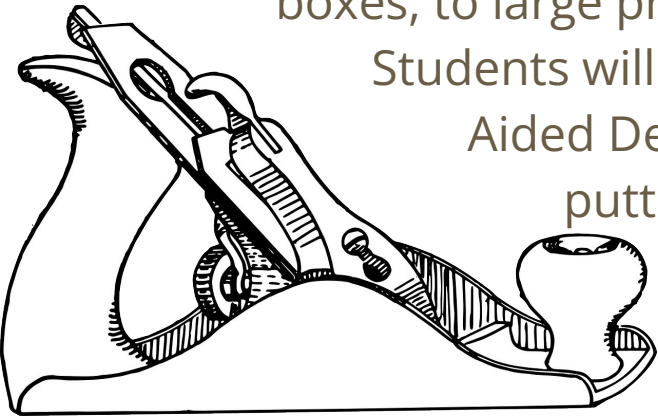
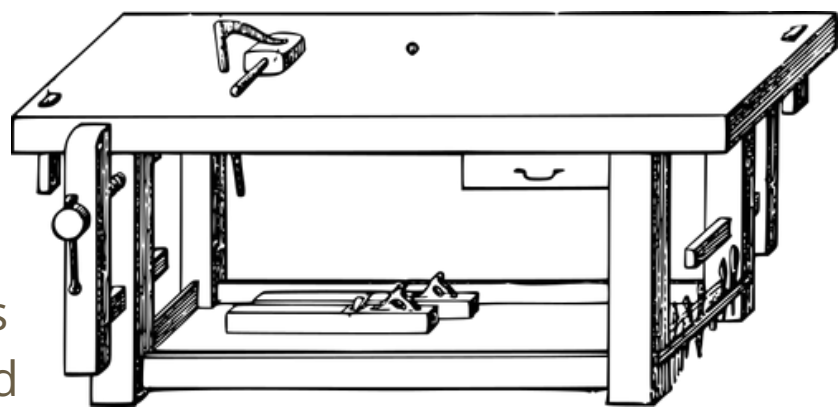



Drama \$10

The overall goal of Drama is to foster a positive self-concept in students by encouraging them to

explore life by the assumption of roles and by the acquisition of dramatic skills. Elements of the following units will be studied:

Orientation, Speech, Theatre, Movement and Improvisation/Acting. Drama is a fun way to enhance your creative side to become characters and dive into various adventures!



EOE - Environmental Outdoor Education \$15

Students will examine the management and conservation of the environment and propose actions that foster the sustainable development and use of resources.



As this option has many activities, students must be willing to participate in all aspects of the program. The course focuses on outdoor leisure activities and environmental issues. Activities may include Fall, Winter, Spring and Summer outdoor activities. Field trips will be charged extra to the fee, and could be up to \$40 total for the term.



Foods \$35

Foods Studies provides a unique learning opportunity where students are constantly engaged in problem solving activities that taste great! The class is structured to allow students to develop food preparation and cooking skills while encouraging them to look at food items in new ways. Students will focus on basic cooking and baking techniques and work their way up to a full meal plan.





French \$15

Prerequisite Required to Take in Highschool- Learning French can open many doors to many jobs in the future! It's the official language of 28 countries, and is widely spoken in parts of Western and Central Africa, on several Caribbean islands, and even on the South American mainland. So, if you hope to travel the world one day, sign up for French! You'll learn how to have conversations with people, how to order food or go shopping - you'll even gain social awareness, and so much more. Plus, who doesn't want to sample some delicious French foods or listen to French music?! Field trips will be charged extra to the fee, and could be up to \$40 total for the term.

bonjour

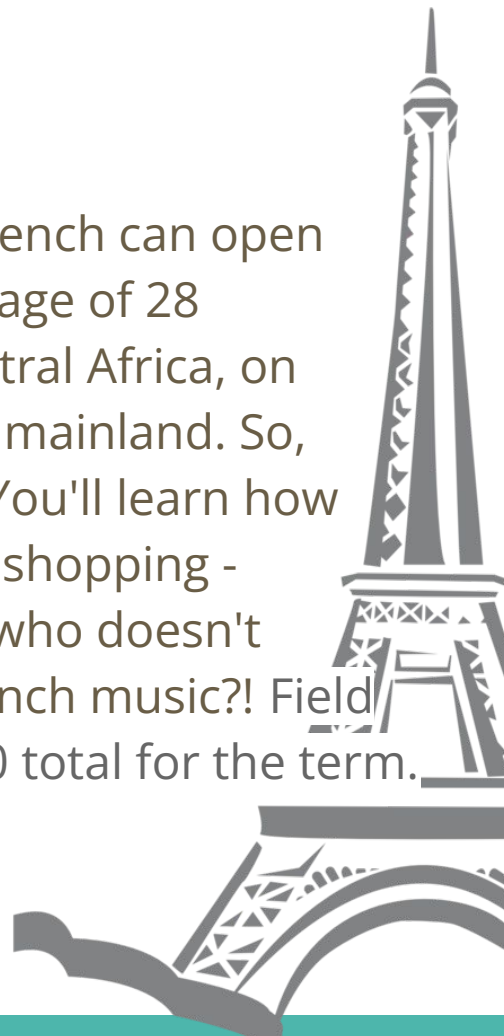



Filipino Language and Culture \$15

According to the 2016 census, Tagalog was the second-most common mother tongue of people living in Edmonton, following English. As a way to learn or improve your

language skills, you will be immersed in this beautiful and rich culture through the sounds of music, the excitement of street games, and the smells and tastes of this culture. Field trips will be charged extra to the fee, and could be up to \$40 total for the term.





Film Studies \$10

The Film Studies course encourages students to become thoughtful and critical viewers. Students explore various film media and examine their impact on personal, community, national and international interests. Students will develop and support personal opinions regarding the cultural value/impact of the film while learning to appreciate the variety and versatility of film. We will recognize the effects of social change on film in terms of the history and development of genres.

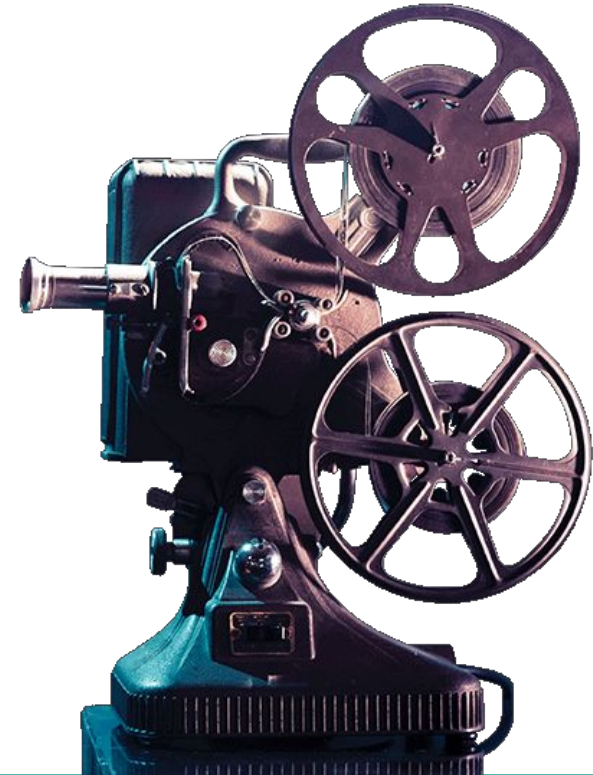

Team Leadership \$5



Team Leadership helps students build their leadership skills within the school as well as outside of the school. Students will learn what characteristics a good leader has, will identify as a specific type of leader, and will apply these to their day to day lives. Students will collaborate to develop ideas, plan, and then execute school wide activities such as fundraisers, theme days, and dances. This is a great option for students to break out of their shell and to meet new people. Field trips will be charged extra to the fee, and could be up to \$40 total for the term.